*

(// // //)

() :

[]

-
-

[]

()

[]

$$v(x) = a_0 + a_1x + a_2x^2 + a_3x^3 + a_4x^4 + a_5x^5$$

$$, -L/2 \leq x \leq L/2 \quad ()$$

$a_5 \quad a_0$

[]

$$v_{imp}(\xi) = \frac{1}{8} v_{imp,0} (\xi^2 - 1)(\xi^2 - 8)$$

$$, \xi = \frac{2x}{L}$$

$$, -L/2 \leq x \leq L/2 \quad ()$$

$v_{imp,0}$

[]

L ξ

()

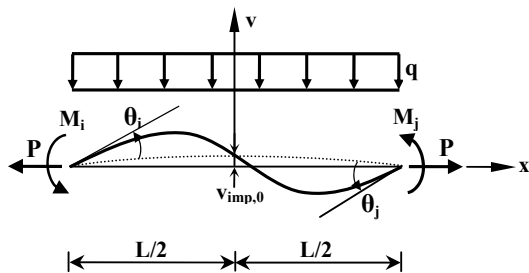

I

$$v|_{x=-L/2} = 0 \quad ()$$

$$v|_{x=L/2} = 0 \quad ()$$

$$v + v_{imp} \quad () \quad v \quad \frac{dv}{dx} \Big|_{x=-L/2} = \theta_i \quad ()$$

$$dv_{imp}/dx \quad \cdot \quad \frac{dv}{dx} \Big|_{x=L/2} = \theta_j \quad ()$$

$$U = \frac{EA}{2} \int_L \left(\frac{du}{dx} \right)^2 dx + \frac{EI}{2} \int_L \left(\frac{d^2v}{dx^2} \right)^2 dx \quad ()$$

$$+ \frac{P}{2} \int_L \left[\left(\frac{dv}{dx} \right)^2 + 2 \left(\frac{dv}{dx} \right) \left(\frac{dv_{imp}}{dx} \right) \right] dx \quad ()$$

$$EI \left(\frac{d^2v}{dx^2} \right)_0 = \frac{1}{2} (M_j - M_i) + \frac{qL^2}{8} + Pv_{imp,0} \quad ()$$

$$EI \left(\frac{d^3v}{dx^3} \right)_0 = \frac{1}{2} (M_i + M_j) + P \left(\frac{dv}{dx} \right)_0 \quad ()$$

$$j \quad i \quad M_j \quad M_i \quad q \quad P \cdot EI \quad 0$$

$$W_q = \int_L (-q)v(x) dx \quad ()$$

$$k_{ij} = \frac{\partial^2 \Pi}{\partial \delta_i \partial \delta_j} \quad , \quad \delta = \{e \quad \theta_i \quad \theta_j\}^T \quad , \quad i, j = 1, 2, 3 \quad ()$$

$$[K_t]_{EB,e} = \frac{EI}{L} \begin{bmatrix} k_{11} & k_{12} & k_{13} \\ \text{(Symmetric)} & k_{22} & k_{23} \\ & & k_{33} \end{bmatrix}$$

$$= \frac{EI}{L} \begin{bmatrix} \frac{1}{L^2 H} & \frac{G_1}{LH} & \frac{G_2}{LH} \\ \left(S_1 + \frac{G_1^2}{H} \right) & \left(S_2 + \frac{G_1 G_2}{H} \right) \\ \text{(Symmetric)} & \left(S_1 + \frac{G_2^2}{H} \right) \end{bmatrix} \quad ()$$

$$\Pi = U + V \quad ()$$

$$U = \int_V \int_\varepsilon \sigma d\varepsilon dV \quad ()$$

$$V = - \left(\sum_{i=1}^n P_i D_i + \int_L q(x)v(x) dx \right) \quad ()$$

$$U = \frac{EA}{2} \int_L \left(\frac{du}{dx} \right)^2 dx + \frac{EI}{2} \int_L \left(\frac{d^2v}{dx^2} \right)^2 dx + \frac{P}{2} \int_L \left(\frac{dv}{dx} \right)^2 dx \quad ()$$

LRFD

[]

$$\frac{E_t}{E} = \begin{cases} 1.0 & P \leq 0.5P_y \\ 4\left(\frac{P}{P_y}\right)\left(1 - \frac{P}{P_y}\right) & P > 0.5P_y \end{cases} \quad ()$$

P

P_y
CRC

CRC

[]

[]

$$\varphi = 1 - \alpha^{(1-P/P_y)} \quad ()$$

$$\alpha = \begin{cases} 0 & M < M_{yc} \\ \frac{M - M_{yc}}{M_{pc} - M_{yc}} \leq 1 & M_{yc} \leq M \leq M_{pc} \end{cases} \quad ()$$

M_{yc}

M

M_{pc}

AISC-LRFD

H G₂ G₁

$$S_1 = \frac{1}{B_1^2 B_2^2} \left[4(80)^2(48)^2 + 32(80)(48)^2 \rho + \left(\frac{689}{56}\right)(80+48)^2 \rho^2 + \left(\frac{314}{105}\right)(80-48)^2 \rho^3 + \left(\frac{716}{35}\right)\rho^4 + \left(-\frac{2}{45}\right)\rho^5 \right] \quad ()$$

$$S_2 = \frac{1}{B_1^2 B_2^2} \left[2(80)^2(48)^2 + 8(80)(48)^2 \rho + \left(\frac{209}{112}\right)(80+48)^2 \rho^2 + \left(\frac{121}{420}\right)(80-48)^2 \rho^3 + \left(\frac{10}{21}\right)\rho^4 - \left(\frac{1}{126}\right)\rho^5 \right] \quad ()$$

$$G_1 = R_1(\theta_i + \theta_j) + R_2(\theta_i - \theta_j) + R_3\left(\frac{qL^3}{EI}\right) + R_4\left(\frac{v_{imp,0}}{L}\right) \quad ()$$

$$G_2 = R_1(\theta_i + \theta_j) - R_2(\theta_i - \theta_j) - R_3\left(\frac{qL^3}{EI}\right) - R_4\left(\frac{v_{imp,0}}{L}\right) \quad ()$$

$$H = \frac{I}{AL^2} - R_5(\theta_i + \theta_j)^2 - R_6(\theta_i - \theta_j)^2 - R_7\left(\frac{qL^3}{EI}\right)(\theta_i - \theta_j) - R_8\left(\frac{v_{imp,0}}{L}\right)(\theta_i - \theta_j) - R_9\left(\frac{qL^3}{EI}\right)^2 - R_{10}\left(\frac{v_{imp,0}}{L}\right)^2 - R_{11}\left(\frac{qL^3}{EI}\right)\left(\frac{v_{imp,0}}{L}\right) \quad ()$$

$$\Delta M_j \quad i \quad \Delta P \quad []$$

$$\eta_2 \quad \eta_1 \quad k^* \quad \frac{P}{0.8P_y} + \frac{fM}{0.9M_p} = 1.0, \quad f = \frac{Z}{S} \quad ()$$

$$k_{11}^* = k_{11} - \frac{k_{12}^2}{k_{22}} \quad () \quad M_p \quad M$$

$$k_{13}^* = k_{13} - \frac{k_{12}k_{23}}{k_{22}} \quad ()$$

$$k_{33}^* = k_{33} - \frac{k_{23}^2}{k_{22}} \quad () \quad []$$

$$\eta_1 = \frac{k_{12}}{k_{22}} \quad () \quad \left(\frac{P}{P_y}\right)^{1.3} + \left(\frac{M}{M_p}\right) = 1 \quad ()$$

$$\eta_2 = \frac{k_{23}}{k_{22}} \quad () \quad M_{yc} = 0.9M_y \left(1 - \frac{P}{0.8P_y}\right) \quad ()$$

$$M_{pc} = M_p \left(1 - \left(\frac{P}{P_y}\right)^{1.3}\right) \quad ()$$

$$[K_t]_{EB,p} = \frac{E_t I}{L} \begin{bmatrix} \left(k_{11} - \frac{k_{12}^2}{k_{22}}(1-\varphi_i)\right) & \varphi_i k_{12} & \left(k_{13} - \frac{k_{12}k_{23}}{k_{22}}(1-\varphi_i)\right) \\ \text{(Symmetric)} & \varphi_i k_{22} & \varphi_i k_{23} \\ & & \left(k_{33} - \frac{k_{23}^2}{k_{22}}(1-\varphi_i)\right) \end{bmatrix} \quad ()$$

$$[K_t]_{EB,p} \quad \varphi_i \quad i \quad \varphi_i \quad j$$

$$[K_t]_{EB,p} = \frac{E_t I}{L} \begin{bmatrix} \left(k_{11} - \frac{k_{13}^2}{k_{33}}(1-\varphi_i)\right) & \left(k_{12} - \frac{k_{13}k_{23}}{k_{33}}(1-\varphi_i)\right) & \varphi_i k_{13} \\ \text{(Symmetric)} & \left(k_{22} - \frac{k_{23}^2}{k_{33}}(1-\varphi_i)\right) & \varphi_i k_{23} \\ & & \varphi_i k_{33} \end{bmatrix} \quad ()$$

$$\varphi_j \quad j \quad \Delta M_{ph,i} \quad M_i \quad []$$

$$\begin{bmatrix} \Delta P \\ \Delta M_i \\ \Delta M_j \end{bmatrix} = \frac{E_t I}{L} \begin{bmatrix} k_{11}^* & 0 & k_{13}^* \\ 0 & 0 & 0 \\ k_{13}^* & 0 & k_{33}^* \end{bmatrix} \begin{bmatrix} \Delta e \\ \Delta \theta_1 \\ \Delta \theta_j \end{bmatrix} + \begin{bmatrix} \eta_1 \\ 1 \\ \eta_2 \end{bmatrix} (\Delta M_{ph,i}) \quad ()$$

$$k^* \quad \eta_2 \quad \eta_1 \quad ()$$

$$[K_t]_{EB,p} = \begin{bmatrix} kp_{11} & kp_{12} & kp_{13} \\ kp_{21} & kp_{22} & kp_{23} \\ kp_{31} & kp_{32} & kp_{33} \end{bmatrix} \quad ()$$

$$kp_{11} = \frac{1}{k_{11}} \left[k_{11} - \frac{k_{12}^2}{k_{22}} (1 - \varphi_i) \right] \left[k_{11} - \frac{k_{13}^2}{k_{33}} (1 - \varphi_j) \right] \quad ()$$

$$kp_{12} = kp_{21} = \varphi_i \left[k_{12} - \frac{k_{13}k_{23}}{k_{33}} (1 - \varphi_j) \right] \quad ()$$

$$kp_{13} = kp_{31} = \varphi_j \left[k_{13} - \frac{k_{12}k_{23}}{k_{22}} (1 - \varphi_i) \right] \quad ()$$

$$kp_{22} = \varphi_i \left[k_{22} - \frac{k_{23}^2}{k_{33}} (1 - \varphi_j) \right] \quad ()$$

$$kp_{23} = kp_{32} = \varphi_i \varphi_j k_{23} \quad ()$$

$$kp_{33} = \varphi_j \left[k_{33} - \frac{k_{23}^2}{k_{22}} (1 - \varphi_i) \right] \quad ()$$

I
()

$$[K_t]_{EG} = [R]^T [K_t]_{EL} [R] \\ = [R]^T \left([T]^T [K_t]_{EB,p} [T] + [RBM] \right) [R] \quad ()$$

[K_t]_{EG} [K_t]_{EL}

()

/ P_y

[T]

4WF13

[R]

GPa

MPa

[RBM]

[] / M_p

()

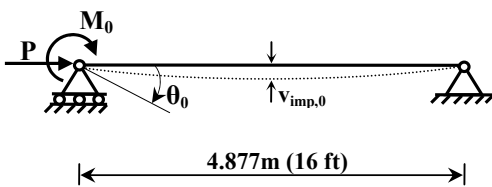

L/ L/

()

/ M_p L/

/ M_p

() / $M_p L$

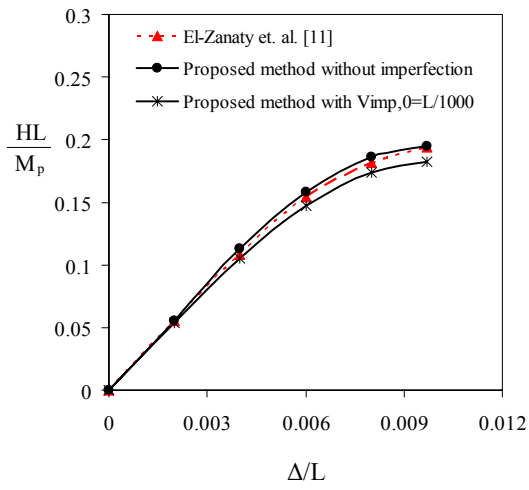
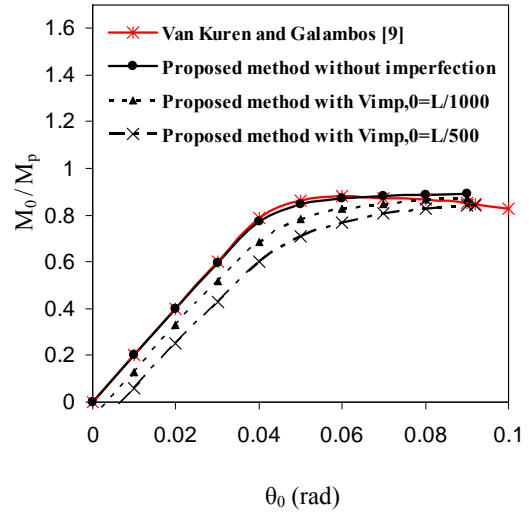
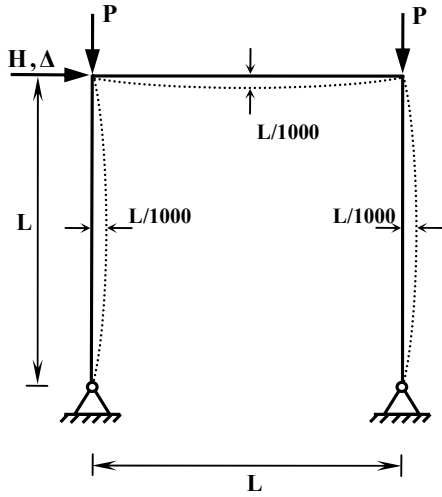

L/ L/

GPa W8×31 MPa

/ P_y

() / P_y / P_y / P_y

Ψ_{ob} Ψ_{oc}

1/432 1/300

1/288 1/200

()

()

()

()

MPa

IPE360

()

GPa

/

[]

/

/

/

[]

/

/

ABAQUS

[]

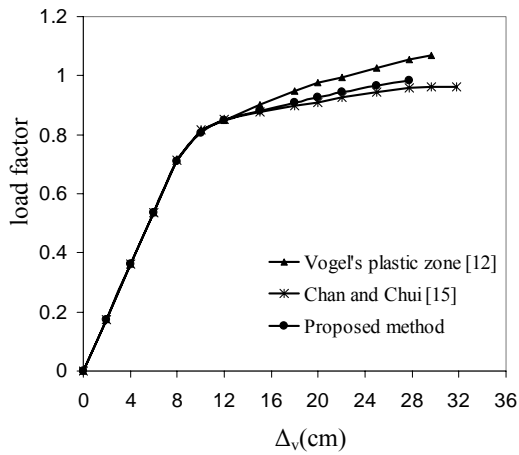
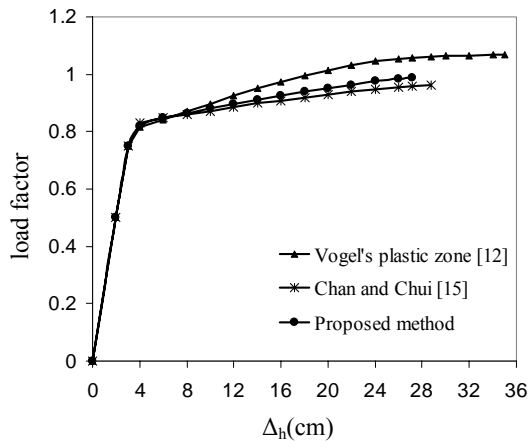
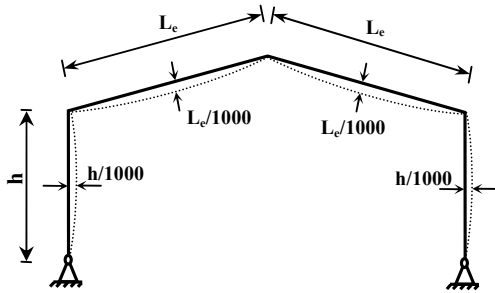

()

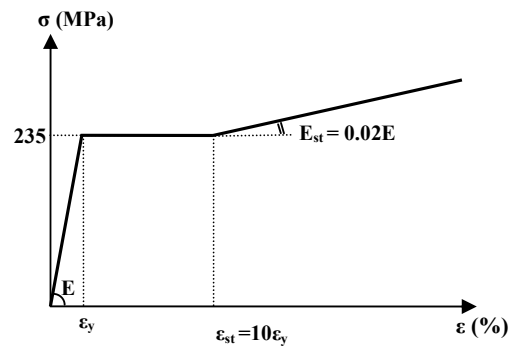
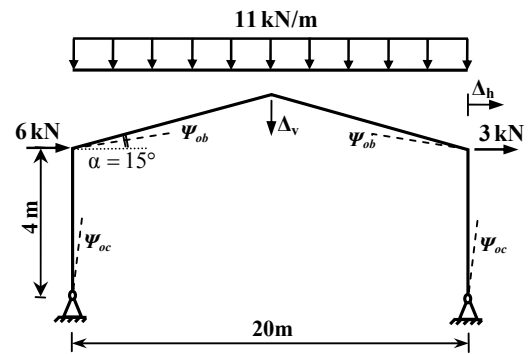

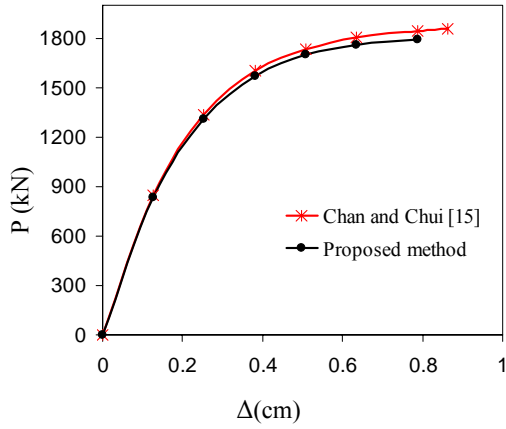

P-Δ

W12×96

W14×48

MPa

(ksi)

GPa

[] (ksi)

() ()

[]

L_b

$$w = 2P/L_b$$

kN

kN

()

()

()

()

[]

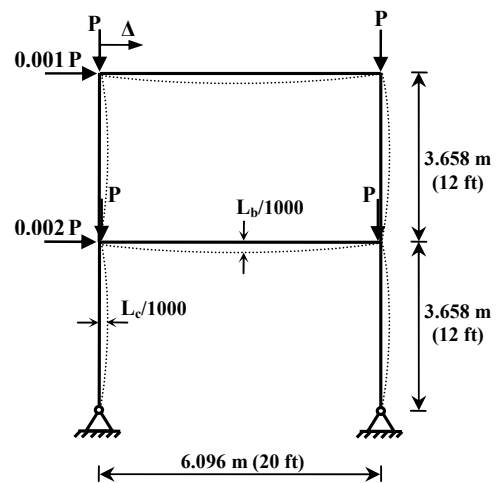
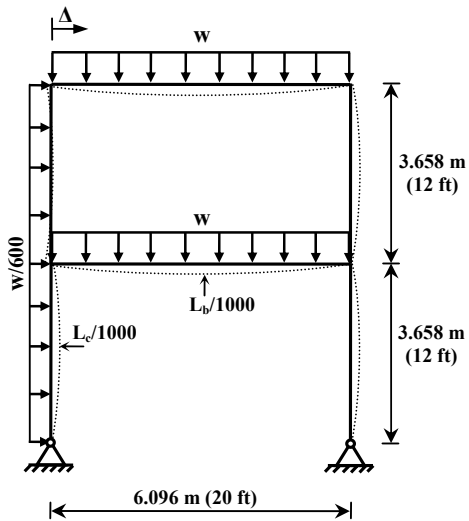

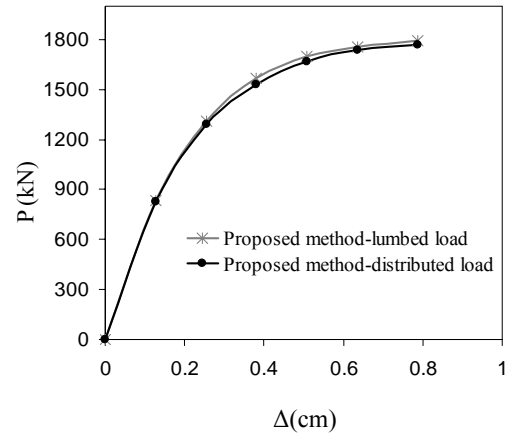
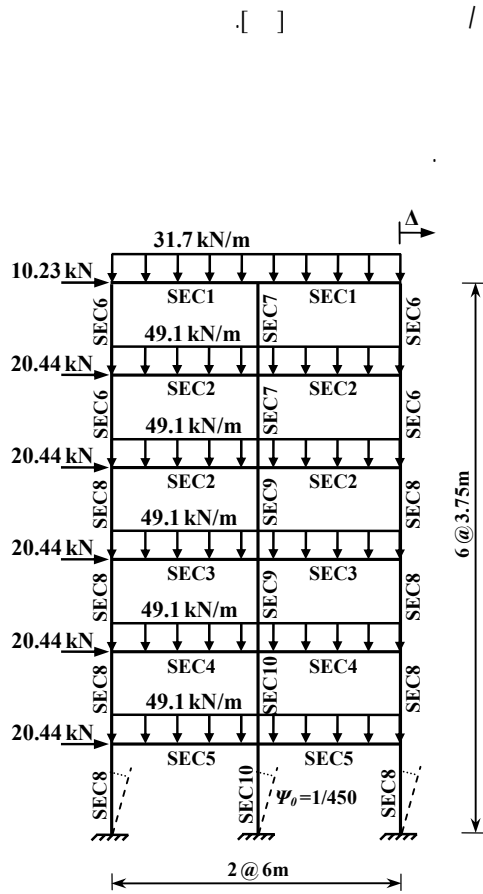

Section Name	Section Name
SEC1 IPE240	SEC6 HEB160
SEC2 IPE300	SEC7 HEB200
SEC3 IPE330	SEC8 HEB220
SEC4 IPE360	SEC9 HEB240
SEC5 IPE400	SEC10 HEB260

() ()

L/ ECCS

L_b $L_b/$

()

MPa /

[] GPa

[] /

[] /

[] /

[] /

[]

ABAQUS

P- δ

[]

/

[] /

P- Δ

P- δ

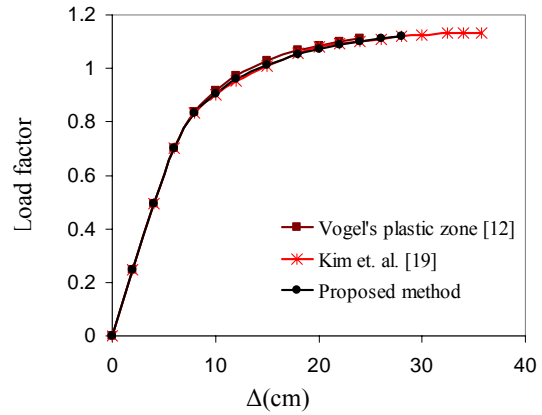

P- Δ P- δ

/

L/

()

/

/

[]

- 1- Chan, S. L. (2001). "Review: nonlinear behavior and design of steel structures." *Journal of Constructional Steel Research*, Vol. 57, PP. 1217-1231.
- 2- Kim, S. E. and Lee, D. H. (2002). "Second-order distributed plasticity analysis of space steel frames." *Engineering Structures*, Vol. 24, PP. 735-744.
- 3- Chan, S. L. and Zhou, Z. H. (1995). "Second-order elastic analysis of frames using single imperfect element per member." *ASCE, Journal of Structural Engineering*, Vol. 121, No. 6, PP. 939-945.
- 4- Chan, S. L. and Gu, J. X. (2000). "Exact tangent stiffness for imperfect beam-column members." *ASCE, Journal of Structural Engineering*, Vol. 126, No. 9, PP. 1094-1102.
- 5- Chen, W. F. and Kim, S. E. (1997). *LRFD steel design using advanced analysis*. CRC Press, Boca Raton, New York.

6- Liew, J. Y. R., White, D. W. and Chen, W. F. (1993). "Second-order refined plastic-hinge analysis for frame design. Part I." *ASCE, Journal of Structural Engineering*, Vol. 119, No. 11, PP. 3196-3216.

7- Ziemian, R.D. and McGuire, W. (2002). "Modified tangent modulus approach, a contribution to plastic hinge analysis" *ASCE, Journal of Structural Engineering*, Vol. 128, No. 10, PP. 1301-1307.

" ()

9- King, W. S., White, D.W. and Chen, W. F. (1992). "Second-order inelastic analysis for steel frame design." *ASCE, Journal of Structural Engineering*, Vol. 118, No. 2, PP. 408-428.

10- Duan, L. and Chen, W. F. (1989). "Design interaction equation for doubly symmetrical sections." *ASCE, Journal of Structural Engineering*, Vol. 115, No. 5, PP. 1225-1243.

11- Toma, S., Chen, W. F. and White, D. W. (1995). "A Selection of calibration frames in North America for second-order inelastic analysis." *Engineering Structures*, Vol. 17, PP. 104-112.

12- Toma, S. and Chen, W.F. (1992). "European calibration frames for second-order inelastic analysis." *Engineering Structures*, Vol. 14, PP. 7-14.

13- Chan, S. L. and Chui, P. P. T. (1997). "A generalized design-based elastoplastic analysis of steel frames by section assemblage concept." *Engineering Structures*, Vol. 19, No. 8, PP. 628-636.

14- Avery, P. and Mahendran, M. (2000). "Distributed plasticity analysis of steel frame structures comprising non-compact sections." *Engineering Structures*, Vol. 22, PP. 901-919.

15- Chan, S. L. and Chui, P. P. T. (2000). *Nonlinear static and cyclic analysis of steel frames with semi-rigid connections*. Elsevier Science, Amsterdam.

16- Zhou, Z. H. and Chan, S. L. (1996). "Refined second-order analysis of frames under lateral and axial loads." *ASCE, Journal of Structural Engineering*, Vol. 122, No. 5, PP. 548-554.

17- Liew, J. Y. R., White, D. W. and Chen, W. F. (1993). "Second-order refined plastic-hinge analysis for frame design. Part II." *ASCE, Journal of Structural Engineering*, Vol. 119, No. 11, PP. 3217-3237.

18- Chen, W. F. and Chan, S. L. (1995). "Second-order inelastic analysis of steel frames using element with midspan and end springs." *ASCE, Journal of Structural Engineering*, Vol. 121, No. 3, PP. 530-541.

19- Kim, S. E., Lee, J. S., Choi, S. H. and Kim, C. S. (2004). "Practical second-order inelastic analysis for steel frames subjected to distributed load." *Engineering Structures*, Vol. 26, PP. 51-61.

$$R_3 = \frac{-16[7(48) + 5\rho]}{35B_2^3} \quad ()$$

$$R_4 = \frac{11(392099 + (33/7)(48)^2\rho + 144\rho^2 + \rho^3)}{60B_2^3} \quad () \quad () \quad ()$$

$$R_5 = \frac{-5120(60 + \rho)}{21B_1^4} \quad ()$$

$$R_6 = \frac{-3072(84 + \rho)}{35B_2^4} \quad ()$$

$$R_7 = \frac{32(384 + 5\rho)}{35B_2^4} \quad ()$$

$$R_8 = \frac{-11[1528181 + 8(48)^2\rho]}{140B_2^4} \quad ()$$

$$R_1 = \frac{1}{B_1^3} \left[4(80)^2 + \left(-\frac{52}{7}\right)(80)\rho + \left(\frac{92}{21}\right)\rho^2 + \left(\frac{23}{1260}\right)\rho^3 \right] \quad ()$$

$$R_2 = \frac{1}{B_2^3} \left[4(48)^2 + \left(\frac{28}{5}\right)(48)\rho + \left(\frac{132}{35}\right)\rho^2 + \left(\frac{11}{420}\right)\rho^3 \right] \quad ()$$

$$[RBM] = \frac{1}{L} \begin{bmatrix} 0 & Q & 0 & 0 & -Q & 0 \\ Q & P & 0 & -Q & -P & 0 \\ 0 & 0 & 0 & 0 & 0 & 0 \\ 0 & -Q & 0 & 0 & Q & 0 \\ -Q & -P & 0 & Q & P & 0 \\ 0 & 0 & 0 & 0 & 0 & 0 \end{bmatrix} \quad ()$$

$$S = \sin \theta \quad C = \cos \theta$$

$$Q = \frac{M_i + M_j}{L}$$

$$R_9 = \frac{-\rho(144 + \rho)}{35B_2^4} \quad ()$$

$$R_{10} = \frac{-256[29(48)^2 + 17(48)\rho]}{35B_2^4} \quad ()$$

$$R_{11} = \frac{32[3120 + 41\rho]}{35B_2^4} \quad ()$$

$$B_1 = \rho + 80 \quad ()$$

$$B_2 = \rho + 48 \quad ()$$

$$\rho = \frac{PL^2}{EI} \quad ()$$

$$: \quad ()$$

$$[T] = \frac{1}{L} \begin{bmatrix} -L & 0 & 0 & L & 0 & 0 \\ 0 & 1 & L & 0 & -1 & 0 \\ 0 & 1 & 0 & 0 & -1 & L \end{bmatrix} \quad ()$$

$$[R] = \begin{bmatrix} R_j & 0 \\ 0 & R_j \end{bmatrix}, \quad [R_j] = \begin{bmatrix} C & S & 0 \\ -S & C & 0 \\ 0 & 0 & 1 \end{bmatrix} \quad ()$$

- | | | |
|------------------------------------|------------------------------------|------------------------------------|
| 1- Geometrical imperfections | 2- Beam-column | 3- Initial out-of-straightness |
| 4- Transverse distributed load | 5- Inelastic | 6- Tangent stiffness matrix |
| 7- Advanced analysis | 8- Planar steel frames | 9- Plastic zone |
| 10- Second-order | 11- Plastic hinge | 12- Elastic-perfectly plastic |
| 13- Basic member coordinates | 14- Total potential energy | 15- Strain energy |
| 16- Stability functions | 17- Residual stress | 18- Tangent modulus |
| 19- Gradual plastification | 20- Stiffness degradation function | 21- Initial yield moment |
| 22- Reduced plastic moment | 23- Initial yield surface | 24- Full yield surface |
| 25- Incremental-iterative strategy | 26- Load control method | 27- Modified Newton-Raphson method |
| 28- Ultimate load factor | 29- Stability | 30- Space shell element |